



BACnet for Acuvim II Series Power Meter User's Manual



Copyright © 2023 V: 2.0.1

This manual may not be altered or reproduced in whole or in part by any means without the expressed written consent of Accuenergy.

The information contained in this document is believed to be accurate at the time of publication, however, Accuenergy assumes no responsibility for any errors which may appear here and reserves the right to make changes without notice. Please ask the local representative for latest product specifications before ordering.

Please read this manual carefully before installation, operation and maintenance of the AcuRev 1310 series meter. The following symbols in this manual are used to provide warning of danger or risk during the installation and operation of the meters.



Electric Shock Symbol: Carries information about procedures which must be followed to reduce the risk of electric shock and danger to personal health.



Safety Alert Symbol: Carries information about circumstances which if not considered may result in injury or death.

Prior to maintenance and repair, the equipment must be de-energized and grounded. All main-

tenance work must be performed by qualified, competent accredited professionals who have received formal training and have experience with high voltage and current devices. Accuenergy shall not be responsible or liable for any damages or injuries caused by improper meter installation and/or operation.

Contents

1. BACnet Overview	3
2. Introduction.....	3
3. About BACnet Protocol	3
4. Using the Acuvim II Series Power Meter’s BACnet Protocol.....	4
5. Using The BACnet Module (AXM-BACnet)	5
5.1 Installation Method	5
5.2 Definition of RJ45 Interface and 485 Interface.....	6
5.3 Initializing The BACnet Modules	7
5.3.1 BACnet/IP module (AXM-BIP)	7
5.3.2 BACnet MS/TP module (AXM-BMS)	10
6. BACnet Objects	14
6.1 AXM-BIP Reading Objects	14
6.2 AXM-BMS Reading Objects.....	19
7. AXM-BIP through the web server	20
7.1 Configuring the BACnet-IP settings	20
7.2 BACnet Protocol Implementation Conformity Statement	24

1. BACnet Overview

The Building Automation and Control Network (BACnet), described in the ANSI/ASHRAE Standard 135-1995, is one of the most widely used building management systems protocols. BACnet was designed to allow communication of building automation and control systems for applications such as heating, ventilating, and air-conditioning control, lighting control, access control, and fire detection systems and their associated equipment. The BACnet protocol provides mechanisms for computerized building automation devices to exchange information, regardless of the particular building service they perform.

2. Introduction

The Acuvim II Series Power Meter supports BACnet communication using BACnet IP communication and also BACnet MS/TP communication. It communicates in native BACnet IP over Ethernet to seamlessly integrate with most building automation/control systems, and communicates with the BACnet MS/TP via the RS485. The Acuvim II Series Power Meter's BACnet MS/TP protocol supports has 56 predefined BACnet objects that lets you track up to 56 measurements while the BACnet IP protocol supports 106 objects which lets you track up 78 measurements and 28 IO parameters.

The Acuvim II Series Power Meter supports native BACnet/IP that lets it act as a BACnet server in any BACnet application. The Acuvim II Series Power Meter's BACnet IP also comes with a Web interface that allows users to configure the BACnet related parameters and read measurements by using a standard browser.

3. About BACnet Protocol

The BACnet protocol operates in a client-server environment. A client machine sends a service request (message) to a server machine; once the service is performed the results are reported back to the client machine. BACnet defines 5 groups (or classes) of 35 message types. For example, one class contains messages for retrieving and manipulating the object properties described above. An example of a common service request in this class is "Read-Property." When the server machine receives this message from a client machine, it locates the requested property of the requested object and sends the value to the client.

The BACnet protocol consists of Objects that contain different kinds of information. Each Object has properties that contain data related to it.

Below is the example from the AXM-BMS(BACnet MSTP protocol) of an Object for Total Watts:

Object_Name, **P_rms**

Object_Type, **AnalogValue**

Object_Instance, **17**

Present_Value, **watt**, tot (value in watts)

For more detailed information, visit the BACnet website at www.bacnet.org.

4. Using the Acuvim II Series Power Meter's BACnet Protocol

Serial and Ethernet Versions

There are different serial and Ethernet based-versions of BACnet. The most common serial version is called BACnet MS/TP while the dominant Ethernet version is BACnet/IP.

BACnet/IP has been developed to allow the BACnet protocol to use TCP/IP networks. You could say that BACnet/IP is a way of hooking BACnet up to the Internet and communicating with different Local Area Networks (LANs). This enables system owners, facility managers, or even external suppliers to access BACnet networks and manage their devices and systems remotely.

Table 4-1

BACnet/IP Characteristics	
Network Type	Ethernet based network using UDP for data transfer.
Topology	Line or star topology (Standard Ethernet topology)
Installation	Ethernet twisted pair cables with RJ45 connectors
Speed	10/100 Mbit/s full duplex
Max. Station	No network limitation of number of nodes.
Data	Up to 1476 bytes per frame

Table 4-2

BACnet/MSTP Characteristics	
Network Type	Serial RS-485 with a Master/Slave Token Passing protocol
Topology	Serial RS-485 with a Master/Slave Token Passing protocol
Installation	Any cable with at least 3 conductors can be used. Distance between nodes depends on baud rate.
Speed	9600 kbit/s, 19200 kbit/s, 38400 kbit/s and 76800 kbit/s
Max. Station	127 MS/TP masters
Data	Up to 480 bytes per telegram frame

5. Using The BACnet Module (AXM-BACnet)

5.1 Installation Method

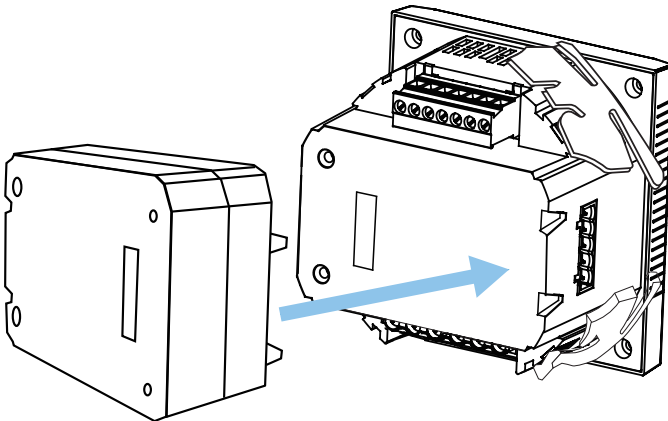

Figure 5-1

The BACnet module is linked to the Acuvim II meter by a communication plug. It can also be linked to other extended modules like IO modules.

1. Insert the installation clips to the counterpart of the meter, and then press the BACnet module lightly, so linking is established.
2. Tighten the installation screws.

Note:

- Install BACnet Module carefully to avoid damage;
- Under no circumstances should any installation be done with the meter powered on. Failure to do so may result in injury or death.

5.2 Definition of RJ45 Interface and 485 Interface

The BACnet/IP module uses a standard RJ45 connector to access the network. The mechanical

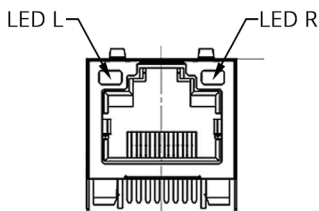

Figure 5-2

and electrical characteristics of the connectors comply with the requirements of IEC 603-7.

Script	ID	Content
1	TX+	Trancieved Data+
2	TX-	Trancieved Data-
3	RX+	Recieved Data+
4	n/c	Not connected
5	n/c	Not connected
6	RX-	Recieved Data-
7	n/c	Not connected
8	n/c	Not connected

Figure 5-3

#	Item
1	Network Status LED
2	Module Status LED
3	BACnet Status LED

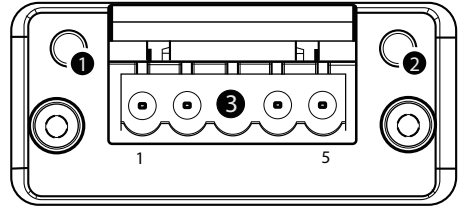

Pin number	Name	Description
1	Common	Signal common
2	Data-	Negative RS485 RxD/TxD
3	Shield	Cable Shield
4	Data+	Positive RS485 RxD/TxD
5	not used	

Figure 5-4

The BACnet MS/TP module uses a standard RS485 connector to access the network.

5.3 Initializing The BACnet Modules

5.3.1 BACnet/IP module (AXM-BIP)

AXM-BIP Module's default settings are as follows:

IP Address (192.168.1.254); Subnet Mask (255.255.255.0); Gateway (192.168.1.1); DNS1 (8.8.8.8); DNS2 (8.8.4.4);

The Acuim II will need to be configured in order to communicate with the AXM-BIP.

The following process shows how to configure BACnet module settings by using the keys on the display:

- Pressing "H" key and "V/A" key simultaneously on the meter will go to the menu selecting mode. The "Meter" cursor flashes in this mode.
- Press the "P" key or "E" key to move the cursor to "Setting". Press "V/A" key to go in to the meter parameter setting mode. Device address page is the first page of "Setting" mode. It shows the Modbus address of the device for several seconds, and then the screen goes to the parameter settings menu. Press the "V/A" key to enter the "SYS" system setting page.



Figure 5-5

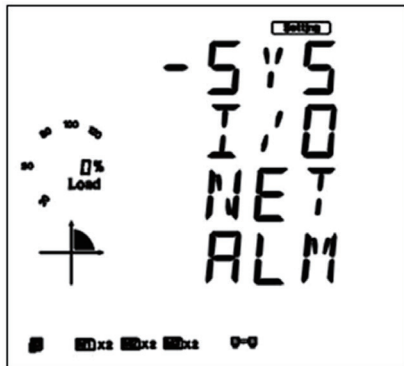

Figure 5-6

- Once in the system settings menu, the initial page is S01 ADDR, the meters RS485 address page. Press the "P" key to go to the S03 BPS2 page. The baud rate should be at 38400.
- Press the "V/A" key to enter edit mode to configure the desired baud rate using the "P" or "E" key. Select 38400. Press the "V/A" key to confirm.
- Press the "P" key or "E" key to move to page S31 Parity2 page. Press the "V/A" key to enter edit mode.
- Press the "P" key or "E" key to change the setting to "1N0" and press the "V/A" key to confirm the setting.

- Press the "P" key or "E" key to move to page S34 PROTOCOL 2 page. Press the "V/A" key to enter edit mode.
- Press the "P" key or "E" key to change the setting to "Other" and press the "V/A" key to confirm the setting
- Press the "H" key to back out of the system settings and press the "E" key to move the cursor to "NET"
- Press "V/A" key to enter the BACnet module settings page to configure the IP address of the AXM-BIP.
- Press the "P" key to move to N02 IP page. If you would like to change it, press the "V/A" key to enter edit mode.

Press 'V/A' to modify; the first digit will begin to flash.

Press 'P' or 'E' to change the number of the flashing digit

Press 'H' to switch the flashing digit

Press 'V/A' to confirm the setting.

- Press the "P" key to move to N03 SUBMASK page. If you would like to change it, press the "V/A" key to enter edit mode and follow the procedure for changing the IP address above.
- Press the "P" key to move to N04 GATEWAY page. If you would like to change it, press the "V/A" key to enter edit mode and follow the procedure for changing the IP address above.
- Press the "P" key to move to N05 DNS1 page. If you would like to change it, press the "V/A" key to enter edit mode and follow the procedure for changing the IP address above.
- Press the "P" key to move to N06 DNS2 page. If you would like to change it, press the "V/A" key to enter edit mode and follow the procedure for changing the IP address above.

After making any changes to the settings above, the AXM-BIP will require a reset in order for the setting to take effect.

- Press the "P" key to move to N09 NET REST page.
- Press "V/A" key to modify; 'NO' should begin to flash
- Press "P" key to change 'NO' to 'RESET'.
- Press "V/A" key to reset the module. 'NO' will be displayed on the screen and the AXM-BIP module settings should now take effect.



Figure 5-7

5.3.2 BACnet MS/TP module (AXM-BMS)

AXM-BMS Module's default settings are as follows :

MAC Addr(0); BACnet Bps(9600); Max Info Pram(1)

The Acuvim II will need to be configured in order to communicate with the AXM-BMS.

The following process shows how to configure BACnet module settings by using the keys on the display:

- Pressing “H” key and “V/A” key simultaneously on the meter will go to the menu selecting mode. The “Meter” cursor flashes in this mode.
- Press the "P" key or "E" key to move the cursor to "Setting". Press “V/A” key to go to the meter parameter setting mode. Device address page is the first page of the “Setting” mode. It shows the Modbus address of the device for several seconds, and then the screen goes to the parameter settings menu. Press the "V/A" key to enter the "SYS" system setting page.



Figure 5-8

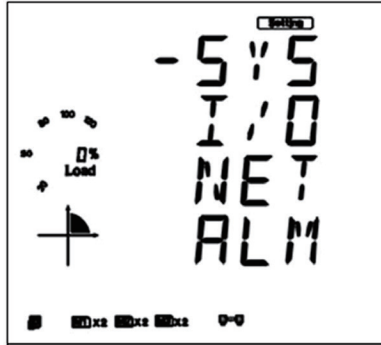

Figure 5-9

- Once in the system settings menu, the initial page is S01 Addr, the meters RS485 address page. Press the "P" key or "E" key to move to page S34 PROTOCOL 2 page. Press the "V/A" key to enter edit mode.
- Press the "P" key or "E" key to change the setting to "BACNET" and press the "V/A" key to confirm the setting.
- Press the "H" key to back out of the system settings and press the "E" key to move the cursor to "NET"
- Press "V/A" key to enter the BACnet module settings page.

The first page of the BACnet related settings is the BACnet MSTP address, which is defaulted to 0. Users can define the range of the address from 0-127.

After setting the BACnet MSTP address, press the "V/A" key to confirm the setting.



Figure 5-10

BACnet for Acuvim II Series Power Meter

- Press the "P" key to move to the second page for the BACnet module baud rate.
- Press the "V/A" key to enter edit mode to select the desired baud rate using the "P" or "E" key. The module supports 9600,19200,38400 and 76800. Press the "V/A" key to confirm.

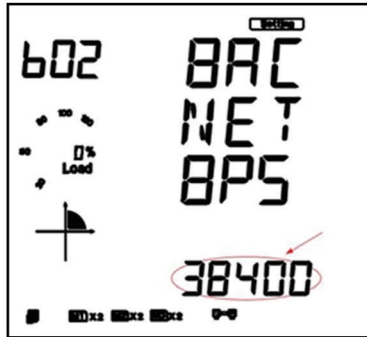

Figure 5-11

- Press the "P" key to move to the third page for the Max Info Frame.
- Press the "V/A" key to enter edit mode to set the desired frame using the "P" or "E" key. Users can define the frame to be from 1-255. Press the "V/A" key to confirm.



Figure 5-12

- Press the "P" key to move to the fourth page for resetting the module after any setting change. Once the reset is complete the new settings will take effect.
- Press the "V/A" key to enter edit mode in order to reset the module using the "P" or "E" key. Select Reset and this will load the module with the modified settings. Press the "V/A" key to confirm.



Figure 5-13

- After configuring the AXM-BMS settings, press "H" key and "V/ A" key simultaneously to return to menu selecting mode.

6. BACnet Objects

6.1 AXM-BIP Reading Objects

The AXM-BIP module for the Acuvim II series power meter supports 78 predefined objects based on the meters real-time measurement parameters. There is no programming or mapping necessary to use the BACnet objects. The object's name easily identifies the measurement they contain.

The following objects have the object type as Analog Inputs. The table below lists each of the objects with their instance number and the units of measurement.

Table 6-1- Analog Inputs

Instance	Object Type	Name	Object Data Type	Units
1	Analog Input	Frequency	Float	Hz
2	Analog Input	Phase A Voltage	Float	V
3	Analog Input	Phase B Voltage	Float	V
4	Analog Input	Phase C Voltage	Float	V
5	Analog Input	Average Line Voltage	Float	V
6	Analog Input	Line Voltage AB	Float	V
7	Analog Input	Line Voltage BC	Float	V
8	Analog Input	Line Voltage CA	Float	V
9	Analog Input	Average Line Voltage	Float	V
10	Analog Input	Phase A Current	Float	A
11	Analog Input	Phase B Current	Float	A
12	Analog Input	Phase C Current	Float	A
13	Analog Input	Average Current	Float	A
14	Analog Input	Neutral Current	Float	A
15	Analog Input	Phase A Active Power	Float	kW
16	Analog Input	Phase B Active Power	Float	kW
17	Analog Input	Phase C Active Power	Float	kW
18	Analog Input	Total Active Power	Float	kW
19	Analog Input	Phase A Reactive Power	Float	kvar
20	Analog Input	Phase B Reactive Power	Float	kvar
21	Analog Input	Phase C Reactive Power	Float	kvar
22	Analog Input	Total Reactive Power	Float	kvar
23	Analog Input	Phase A Apparent Power	Float	kVA
24	Analog Input	Phase B Apparent Power	Float	kVA

Instance	Object Type	Name	Object Data Type	Units
25	Analog Input	Phase C Apparent Power	Float	kVA
26	Analog Input	Total Apparent Power	Float	kVA
27	Analog Input	Phase A Power Factor	Float	
28	Analog Input	Phase B Power Factor	Float	
29	Analog Input	Phase C Power Factor	Float	
30	Analog Input	Total Power Factor	Float	
31	Analog Input	Voltage Unbalance Factor	Float	%
32	Analog Input	Current Unbalance Factor	Float	%
33	Analog Input	Load Type	Float	
34	Analog Input	Active Power Demand	Float	kW
35	Analog Input	Reactive Power Demand	Float	kvar
36	Analog Input	Apparent Power Demand	Float	kVA
37	Analog Input	Phase A Current Demand	Float	A
38	Analog Input	Phase B Current Demand	Float	A
39	Analog Input	Phase C Current Demand	Float	A
40	Analog Input	Import Active Energy	Float	kWh
41	Analog Input	Export Active Energy	Float	kWh
42	Analog Input	Import Reactive Energy	Float	kWh
43	Analog Input	Export Reactive Energy	Float	kWh
44	Analog Input	Energy Total	Float	kWh
45	Analog Input	Energy Net	Float	kWh
46	Analog Input	Reactive Energy Total	Float	kvarh
47	Analog Input	Reactive Energy Net	Float	kvarh
48	Analog Input	Apparent Energy	Float	kVAh
49	Analog Input	Phase A Import Active Energy	Float	kWh
50	Analog Input	Phase A Export Active Energy	Float	kWh
51	Analog Input	Phase B Export Active Energy	Float	kWh
52	Analog Input	Phase B Export Active Energy	Float	kWh
53	Analog Input	Phase C Import Active Energy	Float	kWh

BACnet for Acuvim II Series Power Meter

Instance	Object Type	Name	Object Data Type	Units
54	Analog Input	Phase C Export Active Energy	Float	kWh
55	Analog Input	Phase A Import Reactive Energy	Float	kvarh
56	Analog Input	Phase A Export Reactive Energy	Float	kvarh
57	Analog Input	Phase B Import Reactive Energy	Float	kvarh
58	Analog Input	Phase B Export Reactive Energy	Float	kvarh
59	Analog Input	Phase C Import Reactive Energy	Float	kvarh
60	Analog Input	Phase C Export Reactive Energy	Float	kvarh
61	Analog Input	Phase A Apparent Energy	Float	kVAh
62	Analog Input	Phase B Apparent Energy	Float	kVAh
63	Analog Input	Phase C Apparent Energy	Float	kVAh
64	Analog Input	Phase A Voltage THD	Float	%
65	Analog Input	Phase B Voltage THD	Float	%
66	Analog Input	Phase C Voltage THD	Float	%
67	Analog Input	Average Voltage THD	Float	%
68	Analog Input	Phase A Current THD	Float	%
69	Analog Input	Phase B Current THD	Float	%
70	Analog Input	Phase C Current THD	Float	%
71	Analog Input	Average Current THD	Float	%

Table 6-2-Binary Inputs

Instance	Object Type	Name	Object Data Type
1	Binary Input	IO11-DI1	Bit
2	Binary Input	IO11-DI2	Bit
3	Binary Input	IO11-DI3	Bit
4	Binary Input	IO11-DI4	Bit
5	Binary Input	IO11-DI5	Bit
6	Binary Input	IO11-DI6	Bit
7	Binary Input	IO21-DI1	Bit
8	Binary Input	IO21-DI2	Bit
9	Binary Input	IO21-DI3	Bit

Instance	Object Type	Name	Object Data Type
10	Binary Input	IO21-DI4	Bit
11	Binary Input	IO31-DI1	Bit
12	Binary Input	IO31-DI2	Bit
13	Binary Input	IO31-DI3	Bit
14	Binary Input	IO31-DI4	Bit
15	Binary Input	IO12-DI1	Bit
16	Binary Input	IO12-D2	Bit
17	Binary Input	IO12-DI3	Bit
18	Binary Input	IO12-DI4	Bit
19	Binary Input	IO12-DI5	Bit
20	Binary Input	IO12-DI6	Bit
21	Binary Input	IO22-DI1	Bit
22	Binary Input	IO22-DI2	Bit
23	Binary Input	IO22-DI3	Bit
24	Binary Input	IO22-DI4	Bit
25	Binary Input	IO32-DI1	Bit
26	Binary Input	IO32-DI2	Bit
27	Binary Input	IO32-DI3	Bit
28	Binary Input	IO32-DI4	Bit

Table 6-3- Analog Inputs: IO Module

Instance	Object Type	Name	Object Data Type	Units
1001	Analog Input	IO21-AI1	Float	mA/Volts
1002	Analog Input	IO21-AI2	Float	mA/Volts
1003	Analog Input	IO22-AI3	Float	mA/Volts
1004	Analog Input	IO22-AI4	Float	mA/Volts
1005	Analog Input	IO31-AI1	Float	mA/Volts
1006	Analog Input	IO31-AI2	Float	mA/Volts
1007	Analog Input	IO32-AI3	Float	mA/Volts
1008	Analog Input	IO32-AI4	Float	mA/Volts

Table 6-4- Analog Inputs: DI Counter

Instance	Object Type	Name
2001	Analog Input	IO11-DI1-Counter
2002	Analog Input	IO11-DI2-Counter
2003	Analog Input	IO11-DI3-Counter
2004	Analog Input	IO11-DI4-Counter
2005	Analog Input	IO11-DI5-Counter
2006	Analog Input	IO11-DI6-Counter
2007	Analog Input	IO21-DI1-Counter
2008	Analog Input	IO21-DI2-Counter
2009	Analog Input	IO21-DI3-Counter
2010	Analog Input	IO21-DI4-Counter
2011	Analog Input	IO31-DI1-Counter
2012	Analog Input	IO31-DI2-Counter
2013	Analog Input	IO31-DI3-Counter
2014	Analog Input	IO31-DI4-Counter
2015	Analog Input	IO12-DI1-Counter
2016	Analog Input	IO12-D2-Counter
2017	Analog Input	IO12-DI3-Counter
2018	Analog Input	IO12-DI4-Counter
2019	Analog Input	IO12-DI5-Counter
2020	Analog Input	IO12-DI6-Counter
2021	Analog Input	IO22-DI1-Counter
2022	Analog Input	IO22-DI2-Counter
2023	Analog Input	IO22-DI3-Counter
2024	Analog Input	IO22-DI4-Counter
2025	Analog Input	IO32-DI1-Counter
2026	Analog Input	IO32-DI2-Counter
2027	Analog Input	IO32-DI3-Counter
2028	Analog Input	IO32-DI4-Counter

6.2 AXM-BMS Reading Objects

The AXM-BMS on the Acuvim II Series Power Meter's BACnet IP has 56 predefined objects of electrical measurements. No programming or mapping is necessary to use the BACnet objects. The object's names easily identify the measurements they contain. All of the objects, with the exception of Modbus Meter and POLL_DELAY are AI (analog input) Object type. The following table lists each of the objects with their units of measurement and description.

Table 6-5

Object Type	Instance	Name	Object Data Type	Value	Parameter
Analog Value	0	Freq_rms	Float	ADI1	Frequency
Analog Value	1	Ua_rms	Float	ADI2	Voltage A
Analog Value	2	Ub_rms	Float	ADI3	Voltage B
Analog Value	3	Uc_rms	Float	ADI4	Voltage C
Analog Value	4	Uvavg_rms	Float	ADI5	Average Phase Voltage
Analog Value	5	Uab_rms	Float	ADI6	Voltage A-B
Analog Value	6	Ubc_rms	Float	ADI7	Voltage B-C
Analog Value	7	Uca_rms	Float	ADI8	Voltage C-A
Analog Value	8	Ulavg_rms	Float	ADI9	Average Line Voltage
Analog Value	9	Ia_rms	Float	ADI10	Current A
Analog Value	10	Ib_rms	Float	ADI11	Current B
Analog Value	11	Ic_rms	Float	ADI12	Current C
Analog Value	12	Iavg_rms	Float	ADI13	Average Current
Analog Value	13	In_rms	Float	ADI14	Neutral Current
Analog Value	14	Pa_rms	Float	ADI15	Pa
Analog Value	15	Pb_rms	Float	ADI16	Pb
Analog Value	16	Pc_rms	Float	ADI17	Pc
Analog Value	17	P_rms	Float	ADI18	Total Active Power
Analog Value	18	Qa_rms	Float	ADI19	Qa
Analog Value	19	Qb_rms	Float	ADI20	Qb
Analog Value	20	Qc_rms	Float	ADI21	Qc
Analog Value	21	Q_rms	Float	ADI22	Total Reactive Power
Analog Value	22	Sa_rms	Float	ADI23	Sa
Analog Value	23	Sb_rms	Float	ADI24	Sb
Analog Value	24	Sc_rms	Float	ADI25	Sc
Analog Value	25	S_rms	Float	ADI26	Total Apparent Power
Analog Value	26	PFa_rms	Float	ADI27	PFa
Analog Value	27	PFb_rms	Float	ADI28	PFb
Analog Value	28	PFc_rms	Float	ADI29	PFc
Analog Value	29	PF_rms	Float	ADI30	Total Power Factor
Analog Value	30	Unbl_u2	Float	ADI31	Voltage Imbalance
Analog Value	31	Unbl_i2	Float	ADI32	Current Imbalance
Analog Value	32	Rlc_val	Float	ADI33	Load Characteristics
Analog Value	33	P_dema	Float	ADI34	P Demand
Analog Value	34	Q_dema	Float	ADI35	Q Demand

Object Type	Instance	Name	Object Data Type	Value	Parameter
Analog Value	35	S_dema	Float	ADI36	S Demand
Analog Value	36	Ia_Demand	Float	ADI37	Ia Demand
Analog Value	37	Ib_Demand	Float	ADI38	Ib Demand
Analog Value	38	Ic_Demand	Float	ADI39	Ic Demand
Analog Value	39	Active_Energy_IMP	UINT32	ADI40	Active_Energy_IMP
Analog Value	40	Active_Energy_EXP	UINT32	ADI41	Active_Energy_EXP
Analog Value	41	Reactive_Energy_IMP	UINT32	ADI42	Reactive_Energy_IMP
Analog Value	42	Reactive_Energy_EXP	UINT32	ADI43	Reactive_Energy_EXP
Analog Value	43	Active_Energy_TOTAL	UINT32	ADI44	Active_Energy_TOTAL
Analog Value	44	Active_Energy_NET	SINT32	ADI45	Active_Energy_NET
Analog Value	45	Reactive_Energy_TOTAL	UINT32	ADI46	Reactive_Energy_TOTAL
Analog Value	46	Reactive_Energy_NETS	SINT32	ADI47	Reactive_Energy_NET
Analog Value	47	Apparent_Energy	UINT32	ADI48	Apparent_Energy
Analog Value	48	THD_V1	UINT32	ADI49	THD_V1
Analog Value	49	THD_V2	UINT32	ADI50	THD_V2
Analog Value	50	THD_V3	UINT32	ADI51	THD_V3
Analog Value	51	THD_V	UINT32	ADI52	THD_V
Analog Value	52	THD_I1	UINT32	ADI53	THD_I1
Analog Value	53	THD_I2	UINT32	ADI54	THD_I2
Analog Value	54	THD_I3	UINT32	ADI55	THD_I3
Analog Value	55	THD_I	UINT32	ADI56	THD_I

7. AXM-BIP through the web server

7.1 Configuring the BACnet-IP settings

To configure the BACnet related setting on the AXM-BIP, users must use the built in web server. Ensure the network settings related to the AXM-BIP is configured correctly so it can be accessed by a computer within the Local Area Network.

Chapter 7: AXM-BIP through the web server

- Open an Internet browser and enter the IP address of the meter.

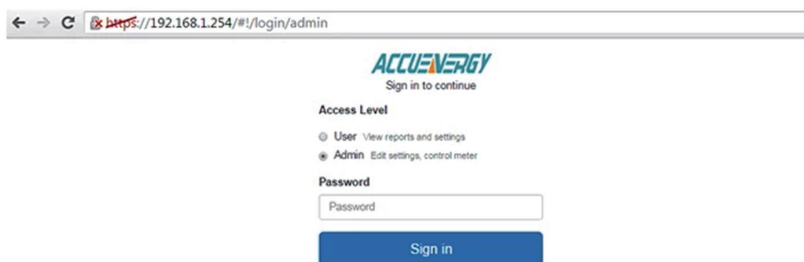

- Login in with 'Admin' access.

NOTE: The default password for the Admin user access is 'admin'.

- Click on 'Settings' and select 'Communications'.

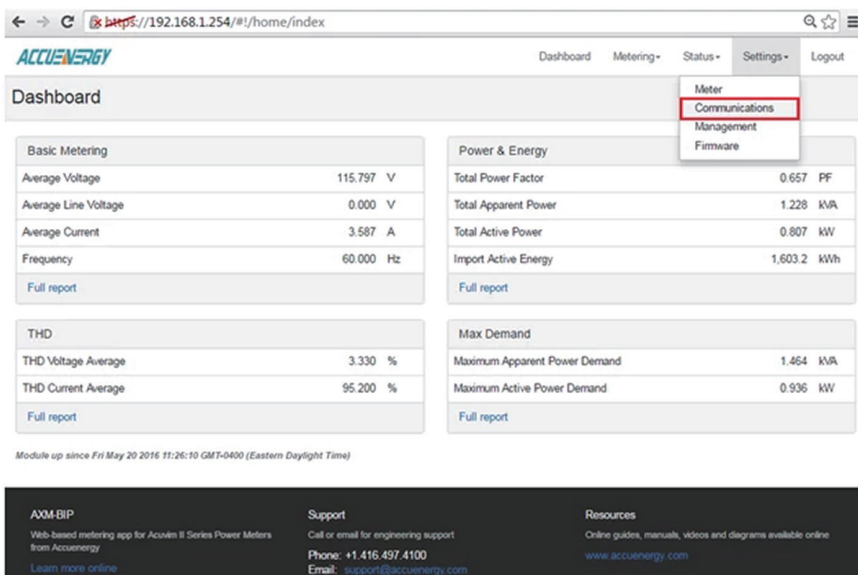

Dashboard

Basic Metering

Average Voltage	115.797 V
Average Line Voltage	0.000 V
Average Current	3.587 A
Frequency	60.000 Hz
Full report	

Power & Energy

Total Power Factor	0.657 PF
Total Apparent Power	1.228 kVA
Total Active Power	0.807 kW
Import Active Energy	1,603.2 kWh
Full report	

THD

THD Voltage Average	3.330 %
THD Current Average	95.200 %
Full report	

Max Demand

Maximum Apparent Power Demand	1.454 kVA
Maximum Active Power Demand	0.936 kW
Full report	

Module up since Fri May 20 2016 11:26:10 GMT-0400 (Eastern Daylight Time)

AXM-BIP
Web-based metering app for AccuLine II Series Power Meters from Accuenergy
[Learn more online](#)

Support
Call or email for engineering support
Phone: +1.416.497.4100
Email: support@accuenergy.com

Resources
Online guides, manuals, videos and diagrams available online
www.accuenergy.com

BACnet for Acuvim II Series Power Meter

- Select the 'BACnet-IP' tab to configure the settings related to BACnet-IP protocol.

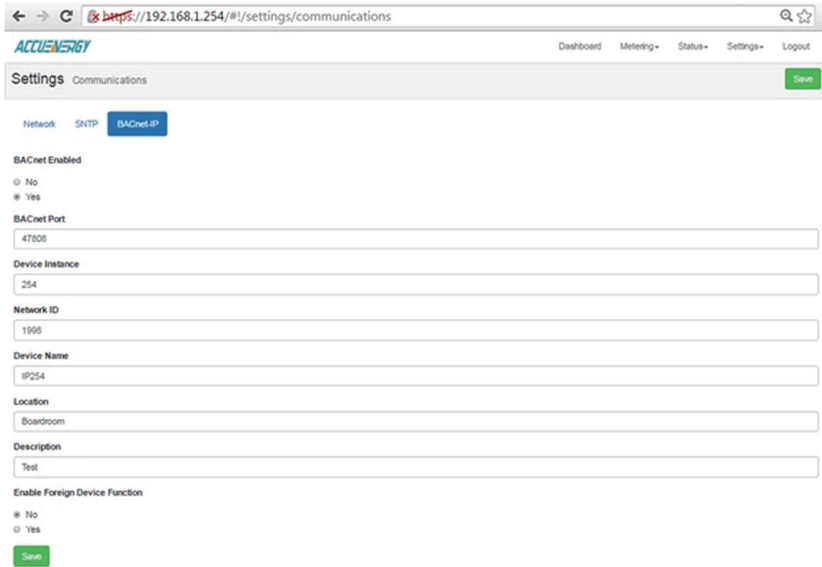

- Under "BACnet Enabled" select 'Yes' to enable the BACnet protocol.

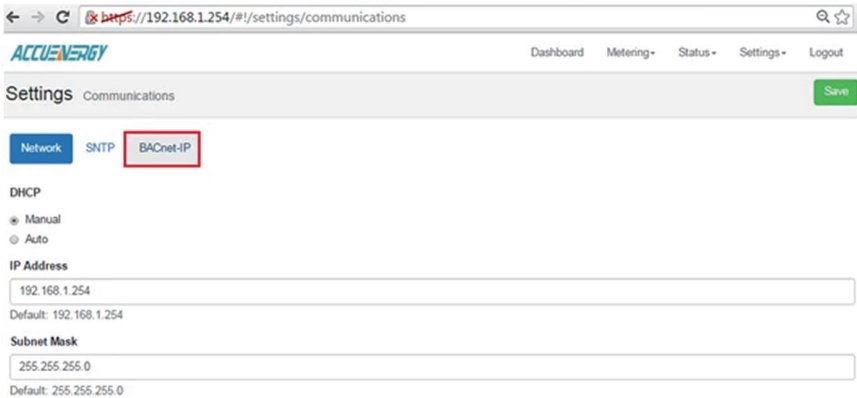

- Enter the "BACnet Port" or the UDP port number. Default port is 47808.
- Enter a "Device Instance" for the device which is the instance number for the device object in the BACnet system. It must be unique within the system.
- Enter the "Network ID" number for the BACnet IP network in which the device resides in. The Network ID would need to be the same for the BACnet devices to communicate with each other.
- Enter a "Device Name" for the device to distinguish it from other devices within the network.

Under the "Enable Foreign Device Function", select 'Enable' to communicate with a BACnet device from another subnet.

- Enter the IP of the BACnet Broadcast Management Device(BBMD) under the 'BBMD IP' field for the device which will receive broadcast messages on one subnet and forward them to another subnet.
- Enter BACnet Port of the BBMD in "BBMD Port"
- Enter a value between 5-1440 min in the "Time To Live" for how often the foreign device will register in the BBMD's foreign device table.

Enable Foreign Device Function

- No
 Yes

BBMD IP

BBMD Port

Time To Live

Enter time in minutes

BACnet for Acuvim II Series Power Meter

- Click 'Save' to save all settings to the module.

The module will require a reboot in order for the settings to take effect.

- Click on 'Settings' and select 'Management'.
- Click on the 'Reset' button on the "Reset Communications Module" option.

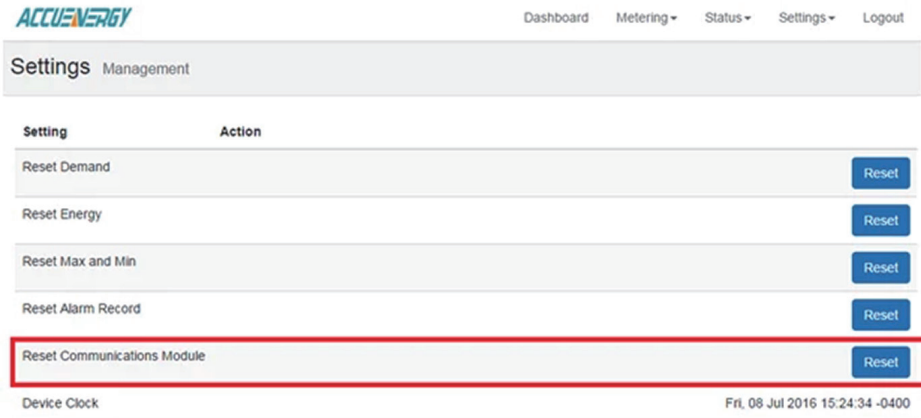

7.2 BACnet Protocol Implementation Conformity Statement

The PICS document for the AXM-BIP can be downloaded from the following URL:

https://accuenergy.com/files/acuvim-ii/EPICS_accu.tpi.zip



MAKE ENERGY USAGE SMARTER

ACCUEENERGY INC.

22 Howden Road
Toronto, ON M1R 3E4, Canada

TF: 1-877-721-8908

INT: +1-416-497-4100

FAX: +1-416-497-4130

E: marketing@accuenergy.com

ACCUEENERGY SOUTH AFRICA (PTY) LTD

Castle Walk Corporate Park,
Block B, Cnr. Nossob & Swakop Street
Erasmuskloof, Pretoria, 0181
South Africa

TF: +27 (0) 87 802 6136

